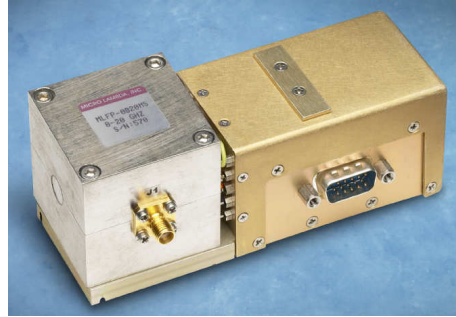

FEATURES

- 500 MHz to 50 GHz
- Compensation for Temperature Drift
- Low-Profile Package
- Input Regulators for Improved Stability
- Versus Power Supply Variations
- 16 Bit Tuning Resolution

DESCRIPTION

MICRO LAMBDA YIG Filters, model types MLFP Series, MLFR-Series and MLFRD-Series are available with integrated serial driver circuits.

MICRO LAMBDA drivers eliminate the need for customers to design or develop their own driver circuits and sophisticated test and alignment procedures. Integrating a driver at MICRO LAMBDA's factory ensures that peak performance will be achieved at the time of manufacture. Alignment and compensation with the particular YIG filter can be maximized down to the component level.

All drivers in this series provide input voltage regulators, and compensation circuits to improve frequency drift.

STANDARD POSITIVE INPUT SERIAL DRIVER SELECTION GUIDE: MS SERIES

MILITARY SERIAL DRIVERS

DRIVER INPUT & RESPONSE
SPECIFICATION (-40 to +85 deg. C)

Tuning Command	Start Word (all 0's) = Lowest Frequency Stop Word (all 1's) = Highest Frequency
Tuning Resolution	16 BIT Positive Logic (Fmax-Fmin)/65,535 Bit Resolution
Tuning Accuracy (excluding hysteresis)	See Table
Tuning Speed	5 mS for 1 GHz step to within ± 10 MHz.
Main Driver Inputs	
Supply Voltage & Current	+15 V \pm .5 V @ Filter Tuning Current +50 mA, Max. -15 V \pm .5 V @ 50 mA
Supply Voltage Pushing	\pm 100 kHz, Max. @ \pm .5 Vdc
Supply Voltage Ripple	10 mV Ripple Pk-Pk from 2 kHz to 3 MHz
Ground	Chassis Ground
YIG Heater Voltage & Current	+24 Vdc \pm 4 Vdc @ 300 - 750 mA surge for 2 seconds, 100 - 150 mA steady state depending on filter type. Polarity independent : ± 12 Vdc or ± 15 Vdc acceptable
Digital Interface	The MLWI digital driver interface is a standard 3-wire connection compatible with SPI/QSPI/MICROWIRE interfaces. The 3-wire serial interface will operate in a 5V or 3.3V logic system. The chip-select input (CSELECTn) frames the serial data loading at the data input pin (DATA). Immediately following CSELECTn's high-to-low transition, the data is shifted synchronously and latched into the input register on the rising edge of the serial-clock input (CLOCK). After 16 data bits have been loaded into the serial input register, it transfers its contents to the DAC latch on CSELECTn's low-to-high transition (Figure 2). Note that if CSELECTn does not remain low during the entire 16 CLOCK cycles, data will be corrupted. In this case, reload the DAC latch with a new 16-bit word.

MS-SERIES — CONT.

YIG Tuned Filters with Military Serial Drivers

Power-On Reset

The MLWI digital driver has a power-on reset circuit to set the DAC's output to OV(F-min) in unipolar mode when VDD is first applied. This ensures that unwanted DAC output voltages will not occur immediately following a system power-up, such as after power loss.

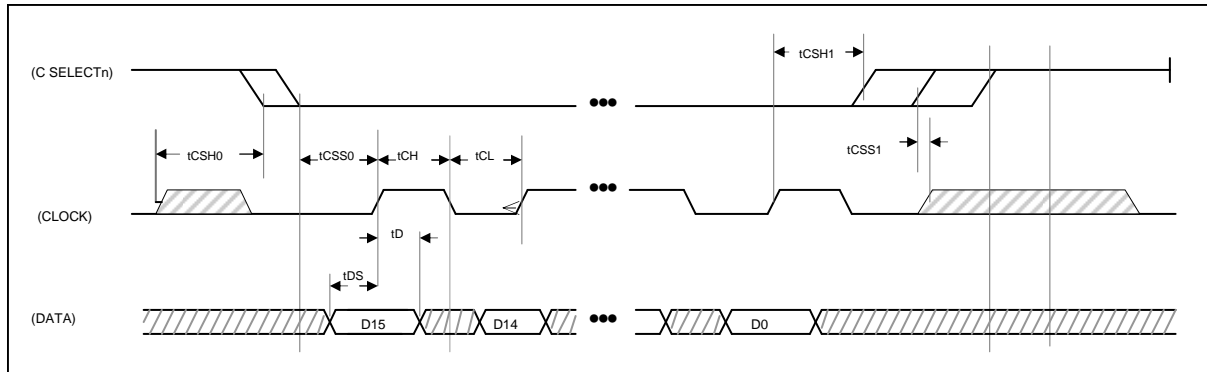

Figure 1. Timing Diagram

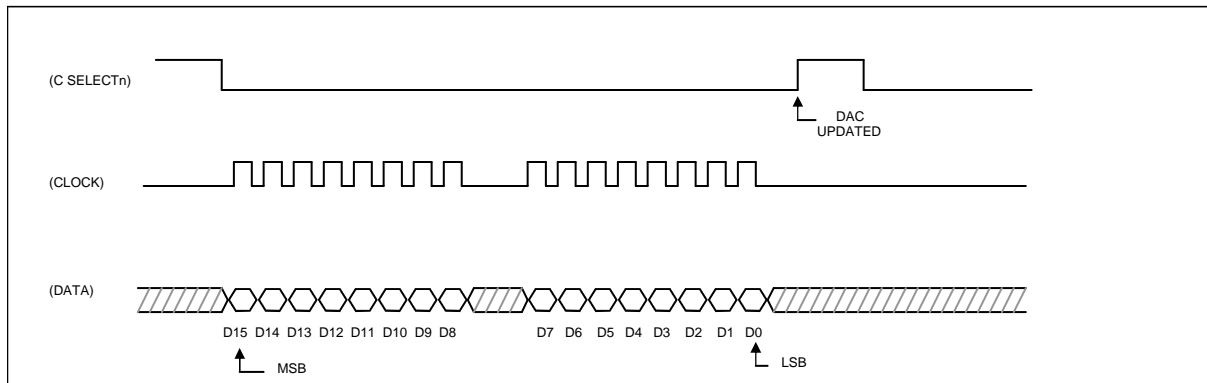

Figure 2. 3-Wire Interface Timing Diagram

TIMING CHARACTERISTICS

PARAMETER	SYMBOL	CONDITIONS	MIN	TYP	MAX	UNITS
CLOCK Frequency	fCLK				10	MHz
CLOCK Pulse Width High	tCH		45			ns
CLOCK Pulse Width Low	tCL		45			ns
CSn Low to CLOCK High Setup	tCSS0		45			ns
CSn High to CLOCK High Setup	tCSS1		45			ns
CLOCK High to CSn Low Hold	tCSH0		30			ns
CLOCK High to CSn High Hold	tCSH1		45			ns
DATA to CLOCK High Setup	tDS		40			ns
DATA to CLOCK High Hold	tDH		0			ns
VDD High to CSn Low (power-up delay)				20		μs



Bandpass Filters with Positive Input Serial Drivers (-40° C to +85° C)

Model Number	# Stages	Frequency GHz	3 dB Bandwidth (MHz)	Accuracy (MHz) *	Current +15V (mA)	Current -15V (mA)	Outline Drawing
MLFP-20520MS	2	.5 to 2.0	20	+/- 20	350	50	21-078
MLFP-22018MS	2	2.0 to 18.0	25	+/- 32	1050	50	21-078
MLFP-22026MS	2	2.0 to 26.5	20	+/- 50	1200	50	21-082
MLFP-40520MS	4	0.5 to 2.0	20	+/- 20	350	50	21-078
MLFP-42008MS	4	2.0 to 8.0	20	+/- 28	550	50	21-078
MLFP-42018MS	4	2.0 to 18.0	40	+/- 32	1050	50	21-078
MLFP-42026MS	4	2.0 to 26.5	25	+/- 50	1200	50	21-082
MLFP-43040MS	4	3.0 to 40.0	30	+/- 65	1450	50	21-131
MLFP-43044MS	4	3.0 to 44.0	30	+/- 75	1550	50	21-131
MLFP-43050MS	4	3.0 to 50.0	30	+/- 105	2100	50	21-131
MLFP-46018MS	4	6.0 to 18.0	100	+/- 30	1050	50	21-078
MLFP-47040MS	4	7.0 to 40.0	35	+/- 65	1450	50	21-131
MLFP-48018MS	4	8.0 to 18.0	400	+/- 60	1050	50	21-078
MLFP-41840MS	4	18.0 to 40.0	50	+/- 65	1450	50	21-131
MLFP-62018MS	6	2.0 to 18.0	40	+/- 32	1050	50	21-079
MLFP-62026MS	6	2.0 to 26.5	30	+/- 50	1350	50	21-069
MLFP-66018MS	6	6.0 to 18.0	100	+/- 30	1050	50	21-079
MLFP-68018MS	6	8.0 to 18.0	500	+/- 50	1050	50	21-079
MLFP-70520MS	7	0.5 to 2.0	20	+/- 20	350	50	21-079
MLFP-72018MS	7	2.0 to 18.0	40	+/- 50	1050	50	21-079
MLFP-72026MS	7	2.0 to 26.5	30	+/- 65	1350	50	21-069
MLFP-76018MS	7	6.0 to 18.0	500	+/- 60	1050	50	21-079
MLFP-76018LMS	7-L	6.0 to 18.0	500	+/- 60	1050	50	21-079
MLFP-78018LMS	7-L	8.0 to 18.0	500	+/- 60	1050	50	21-079
MLFP-78020MS	7	8.0 to 20.0	500	+/- 60	1150	50	21-079
MLFP-78020LMS	7-L	8.0 to 20.0	500	+/- 60	1150	50	21-079

* Accuracy includes frequency drift and linearity errors over the temperature range.

Band Reject Filters with Positive Input Serial Drivers (-40° C to +85° C)

Model Number	Frequency GHz	3 dB Bandwidth (MHz)	40 dB Bandwidth	Accuracy (MHz) *	Current +15 V (mA)	Current -15 V (mA)	Outline Drawing
MLFR-0102MS	1.0 to 2.0	100	10	+/- 10	250	50	21-070
MLFR-0204MS	2.0 to 4.0	125	15	+/- 12	350	50	21-070
MLFR-0408MS	4.0 to 8.0	150	20	+/- 15	550	50	21-070
MLFR-0812MS	8.0 to 12.4	150	25	+/- 17	750	50	21-070
MLFR-1218MS	12.4 to 18.0	150	25	+/- 23	1050	50	21-070
MLFR-0502MS	.50 to 2.0	150	5	+/- 12	250	50	21-070
MLFR-0206MS	2.0 to 6.0	150	20	+/- 16	450	50	21-070
MLFR-0208MS	2.0 to 8.0	150	15	+/- 18	550	50	21-070
MLFR-0212MS	2.0 to 12.0	150	10	+/- 20	750	50	21-070
MLFR-0218MS	2.0 to 18.0	150	10	+/- 30	1050	50	21-070
MLFR-0220MS	2.0 to 20.0	150	5	+/- 30	1050	50	21-070
MLFR-0418MS	4.0 to 18.0	150	10	+/- 27	1050	50	21-070
MLFR-160418MS	4.0 to 18.0	150	25	+/- 27	1050	50	21-070
MLFR-0618MS	6.0 to 18.0	150	25	+/- 27	1050	50	21-070
MLFR-160618MS	6.0 to 18.0	150	25	+/- 27	1050	50	21-070
MLFR-0818MS	8.0 to 18.0	150	35	+/- 27	1050	50	21-070
MLFR-160818MS	8.0 to 18.0	150	35	+/- 27	1050	50	21-070

Dual Channel Band Reject Filters with Positive Input Serial Drivers (-40° C to +85° C)

Model Number	Frequency GHz	3 dB Bandwidth (MHz)	40 dB Bandwidth	Accuracy (MHz) *	Current +15 V (mA)	Current -15 V (mA)	Outline Drawing
MLFRD-0206MS	2.0 to 6.0	120	5	+/- 16	450	50	21-113
MLFRD-0208MS	2.0 to 8.0	120	5	+/- 18	550	50	21-113
MLFRD-0618MS	6.0 to 18.0	100	15	+/- 27	1050	50	21-113
MLFRD-0818MS	8.0 to 18.0	100	15	+/- 27	1050	50	21-113

* Accuracy includes frequency drift and linearity errors over the temperature range.

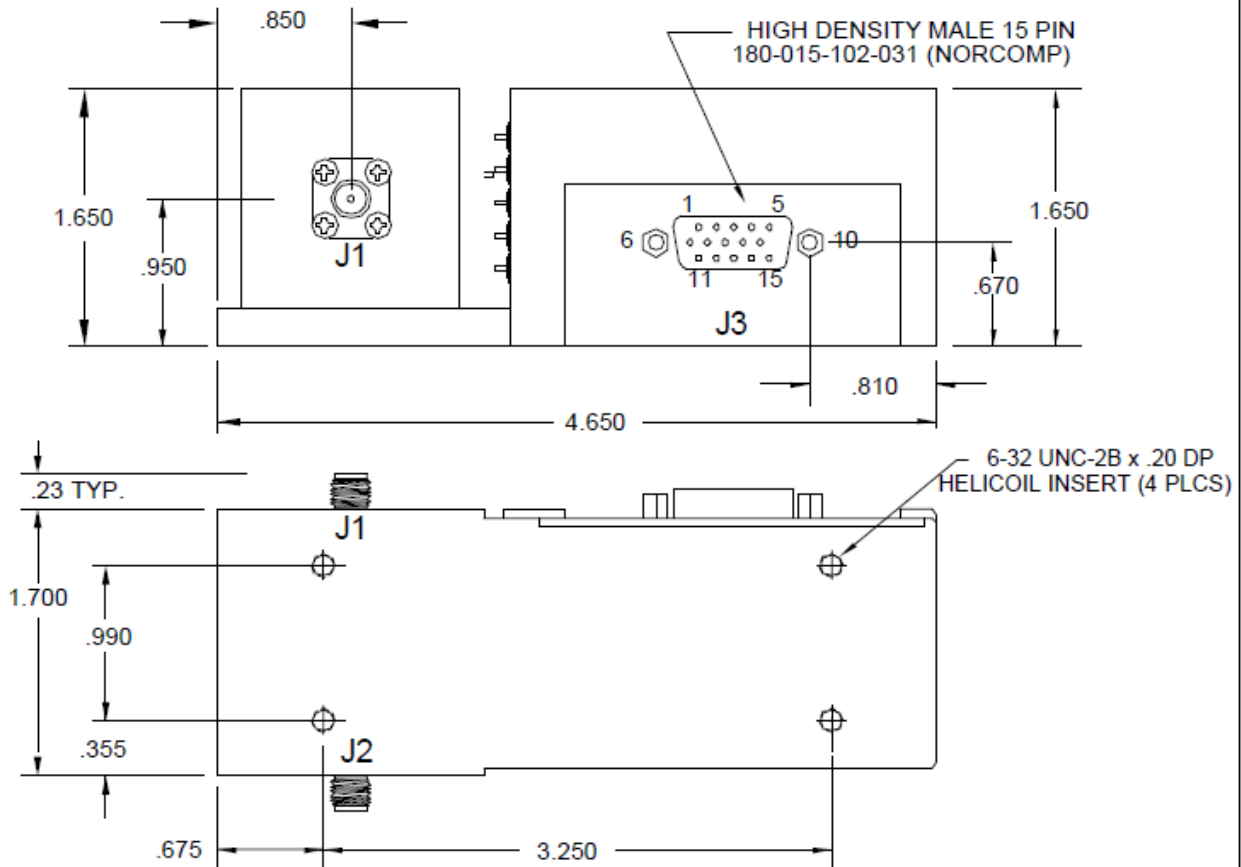

NOTES :

- DIMENSIONS ARE IN INCHES
- SUPPLY & GROUND WIRES = 20-22 GAUGE
ALL OTHER WIRES = 24-26 GAUGE
- THERMAL COMPOUND REQUIRED BETWEEN
BASE PLATE AND MOUNTING SURFACE

CONNECTIONS			
CONN.	TYPE	PIN #	FUNCTION
J1	SMA FEMALE	THD	RF IN
J2	SMA FEMALE	THD	RF OUT

CONNECTIONS			
CONN.	TYPE	PIN #	FUNCTION
J3	DB15 MALE	1	CLOCK
J3	DB15 MALE	2	DATA
J3	DB15 MALE	3	C SELECT N
J3	DB15 MALE	4	GROUND
J3	DB15 MALE	5	- V SUPPLY
J3	DB15 MALE	6	+ V SUPPLY
J3	DB15 MALE	7	HEATER 1
J3	DB15 MALE	8	HEATER 2
J3	DB15 MALE	9	N/C
J3	DB15 MALE	10	N/C
J3	DB15 MALE	11	N/C
J3	DB15 MALE	12	N/C
J3	DB15 MALE	13	N/C
J3	DB15 MALE	14	N/C
J3	DB15 MALE	15	N/C

UNLESS OTHERWISE SPECIFIED DIMENSIONS ARE IN INCHES
TOLERANCE ARE:
FRACTIONS DECIMALS ANGLES
▲ ▲ ▲
▲ ▲ ▲
▲ ▲ ▲

WEIGHT 20 oz.

FINISH

DO NOT SCALE DRAWING

CONTRACT NO.

APPROVALS DATE

DRAWN N. NGUYEN 5/25/04

ENGR.

MANUF.

D.A.



MICRO LAMBDA WIRELESS, INC.

1.4" BPF WITH 16 BIT SERIAL DRIVER

SIZE	CAGE No	DWG. No.	REV.
	0RN63	21 - 078	

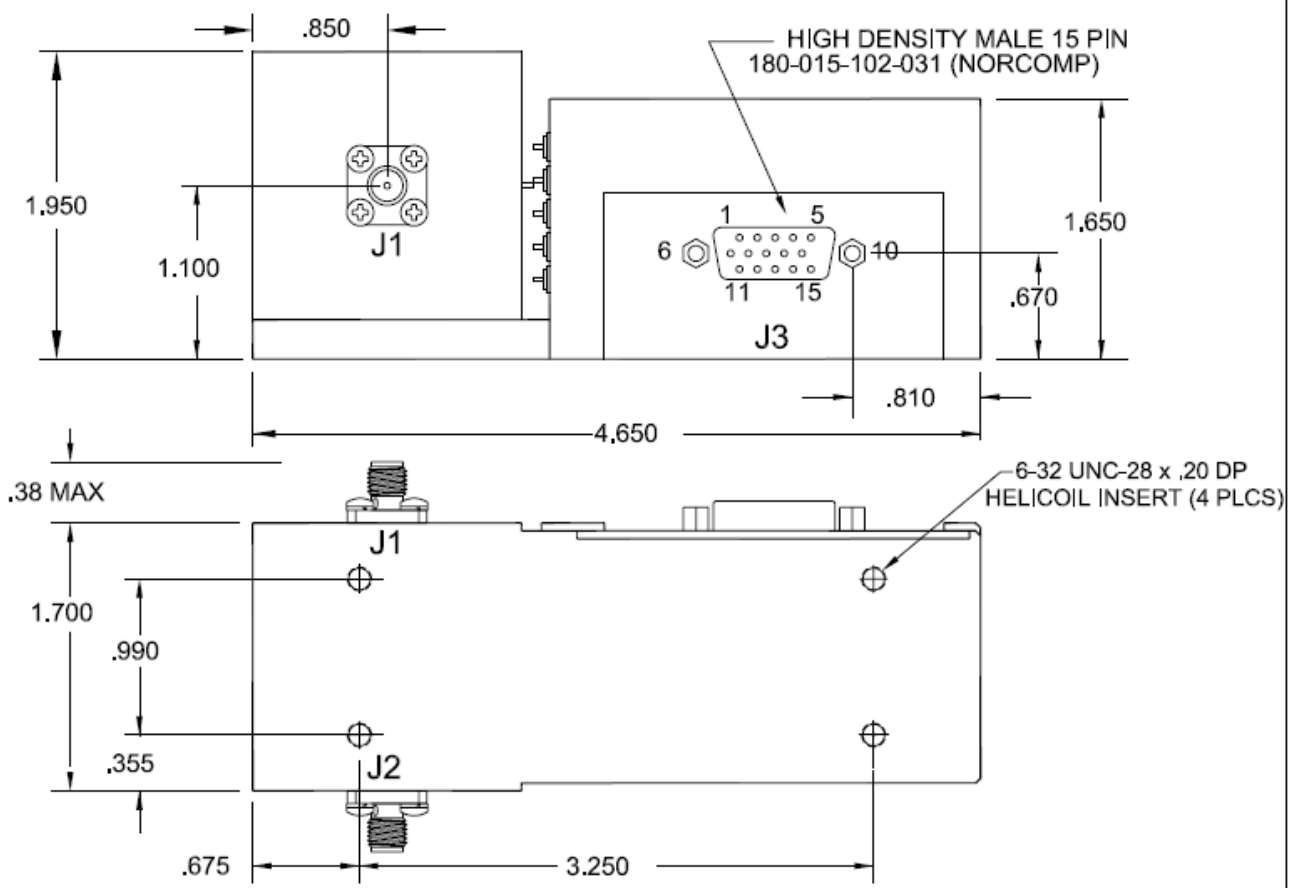

NOTES :

- 1. - DIMENSIONS ARE IN INCHES
- 2. - SUPPLY & GROUND WIRES = 20-22 GAUGE
ALL OTHER WIRES = 24-26 GAUGE
- 3. - THERMAL COMPOUND REQUIRED BETWEEN
BASE PLATE AND MOUNTING SURFACE

CONNECTIONS			
CONN.	TYPE	PIN #	FUNCTION
J1	SMA FEMALE	THD	RF IN
J2	SMA FEMALE	THD	RF OUT

CONNECTIONS			
CONN.	TYPE	PIN #	FUNCTION
J3	DB15 MALE	1	CLOCK
J3	DB15 MALE	2	DATA
J3	DB15 MALE	3	C SELECT N
J3	DB15 MALE	4	GROUND
J3	DB15 MALE	5	- V SUPPLY
J3	DB15 MALE	6	+ V SUPPLY
J3	DB15 MALE	7	HEATER 1
J3	DB15 MALE	8	HEATER 2
J3	DB15 MALE	9	N/C
J3	DB15 MALE	10	N/C
J3	DB15 MALE	11	N/C
J3	DB15 MALE	12	N/C
J3	DB15 MALE	13	N/C
J3	DB15 MALE	14	N/C
J3	DB15 MALE	15	N/C

UNLESS OTHERWISE SPECIFIED DIMENSIONS ARE IN INCHES
TOLERANCE ARE:
FRACTIONS DECIMALS ANGLES
± .005 ± .005 ± .005
WEIGHT 20 oz.
FINISH
DO NOT SCALE DRAWING

CONTRACT NO.
APPROVALS DATE
DRAWN N. NGUYEN 7/29/04
ENGR.
MFG.
Q.A.



MICRO LAMBDA WIRELESS, INC.

1.7" BPF W/ 16 BIT SERIAL DRIVER

SIZE	CAGE No	DWG. NO.	REV.
	0RN63	21 - 082	

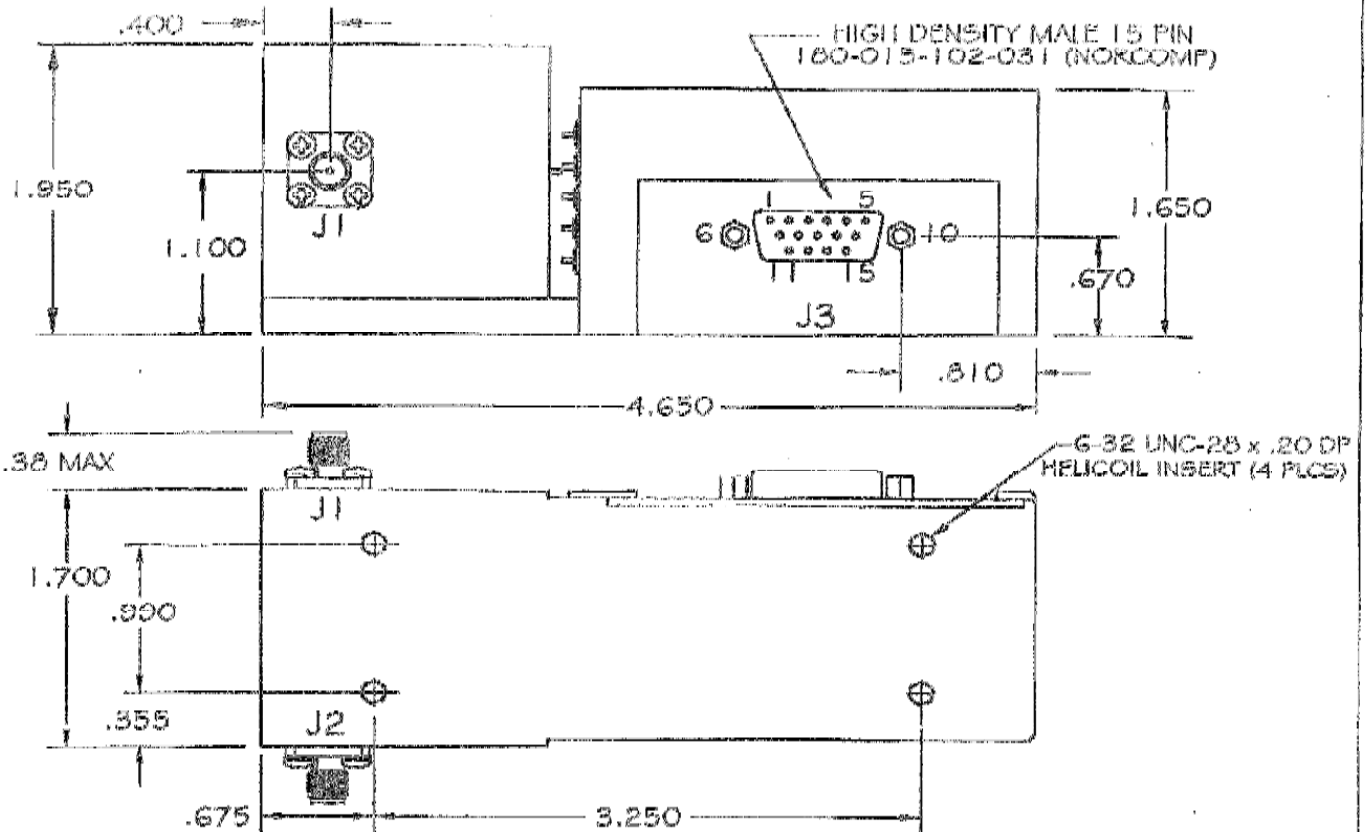

NOTES :

1. - DIMENSIONS ARE IN INCHES
2. - SUPPLY & GROUND WIRES = 20-22 GAUGE
ALL OTHER WIRES = 24-26 GAUGE
3. - THERMAL COMPOUND REQUIRED BETWEEN
BASE PLATE AND MOUNTING SURFACE

CONNECTIONS			
CONN.	TYPE	PIN #	FUNCTION
J1	SMA FEMALE	THD	RF IN
J2	SMA FEMALE	THD	RF OUT

CONNECTIONS			
CONN.	TYPE	PIN #	FUNCTION
J3	DB15 MALE	1	CLOCK
J3	DB15 MALE	2	DATA
J3	DB15 MALE	3	C SELECT N
J3	DB15 MALE	4	GROUND
J3	DB15 MALE	5	- V SUPPLY
J3	DB15 MALE	6	+ V SUPPLY
J3	DB15 MALE	7	HEATER 1
J3	DB15 MALE	8	HEATER 2
J3	DB15 MALE	9	NC
J3	DB15 MALE	10	NC
J3	DB15 MALE	11	NC
J3	DB15 MALE	12	NC
J3	DB15 MALE	13	NC
J3	DB15 MALE	14	NC
J3	DB15 MALE	15	NC

UNLESS OTHERWISE SPECIFIED DIMENSIONS ARE IN INCHES FRACTIONS: DENOMINATOR SHALL BE 16 OR 32 DECIMALS: ROUND UP TO NEXT HIGHER DECIMAL TOLERANCES: ± .005		CONTRACT NO.			MICRO LAMBDA WIRELESS, INC.	
DATE	DESIGNER	APPROVED	DATE		1.2" BPF (OFFSET CONN.) W/MILITARY 16 BIT SERIAL DRIVER	
REV	QUANTITY	REV	DATE	SIZE	DWG. NO.	REV.
1	20 ea.	1	4/25/03	ORNG3	21-069	
DO NOT SCALE DRAWING		DRAWN BY: [Signature]				

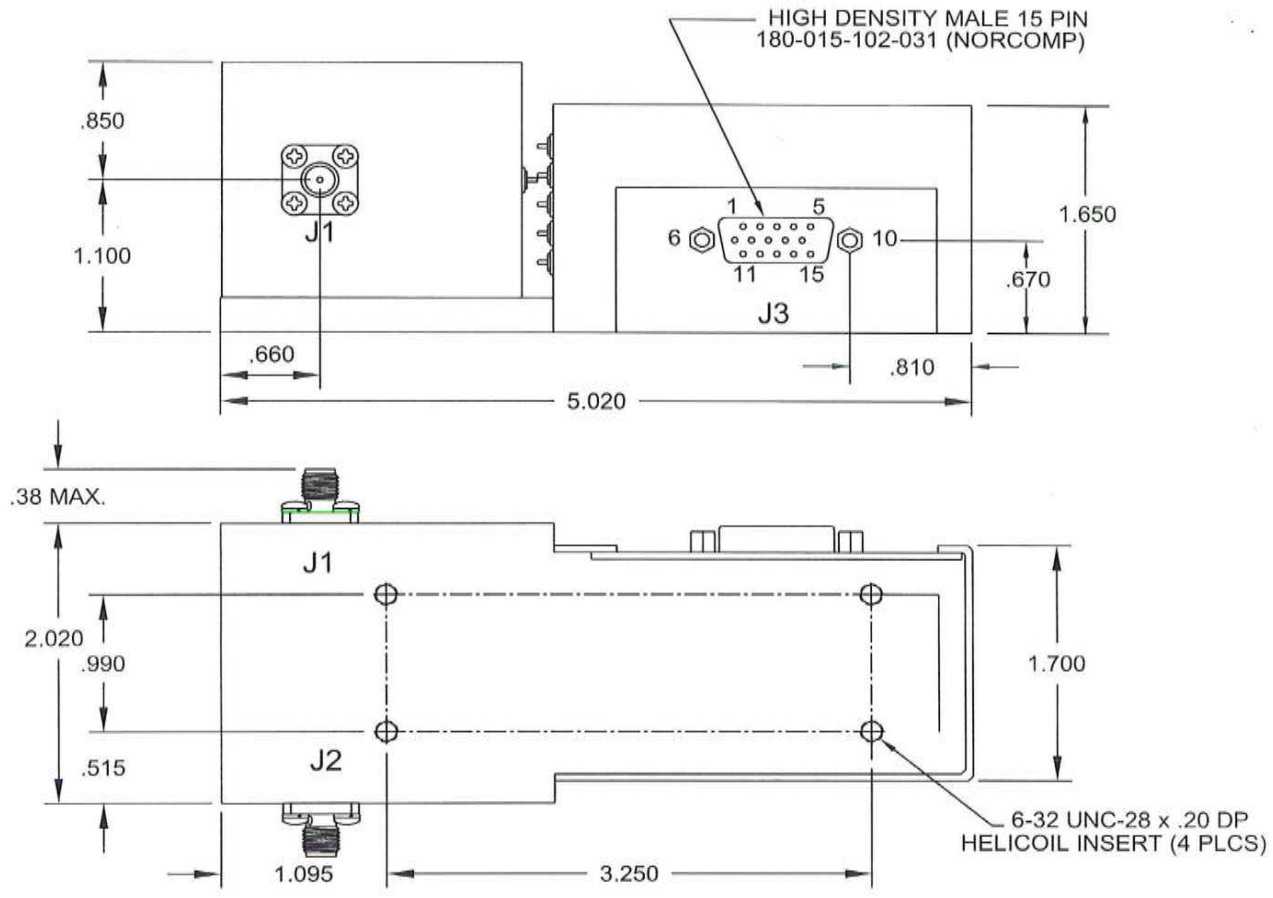

- NOTES :**
1. - DIMENSIONS ARE IN INCHES
 2. - SUPPLY & GROUND WIRES = 20-22 GAUGE
ALL OTHER WIRES = 24-26 GAUGE
 3. - THERMAL COMPOUND REQUIRED BETWEEN
BASE PLATE AND MOUNTING SURFACE

CONNECTIONS			
CONN.	TYPE	PIN #	FUNCTION
J3	DB15 MALE	1	CLOCK
J3	DB15 MALE	2	DATA
J3	DB15 MALE	3	C SELECT N
J3	DB15 MALE	4	GROUND
J3	DB15 MALE	5	- V SUPPLY
J3	DB15 MALE	6	+ V SUPPLY
J3	DB15 MALE	7	HEATER 1
J3	DB15 MALE	8	HEATER 2
J3	DB15 MALE	9	N/C
J3	DB15 MALE	10	N/C
J3	DB15 MALE	11	N/C
J3	DB15 MALE	12 *	N/C
J3	DB15 MALE	13	N/C
J3	DB15 MALE	14	N/C
J3	DB15 MALE	15	N/C

CONNECTIONS			
CONN.	TYPE	PIN #	FUNCTION
J1	K-CON. FEMALE	THD	RF IN
J2	K-CON. FEMALE	THD	RF OUT

<small>UNLESS OTHERWISE SPECIFIED DIMENSIONS ARE IN INCHES. TOLERANCE ARE:</small> <small>FRACTIONS DECIMALS ANGLES</small> <small>• .XX .020</small> <small>• .XXX .005</small> <small>•</small> WEIGHT 20 oz. FINISH DO NOT SCALE DRAWING	CONTRACT NO.	
	APPROVALS	DATE
	DRAWN N.NGUYEN	12/17/13
	ENGR DS	12/17/13
	MANUF.	
	O.A.	

MICRO LAMBDA WIRELESS, INC.

BPF (2.0" X 1.7") >26.5 GHz; 16 BIT SERIAL DRIVER

SIZE	CAGE No 0RN63	DWG. NO. 99 - 0021 - 131	REV
------	------------------	-----------------------------	-----

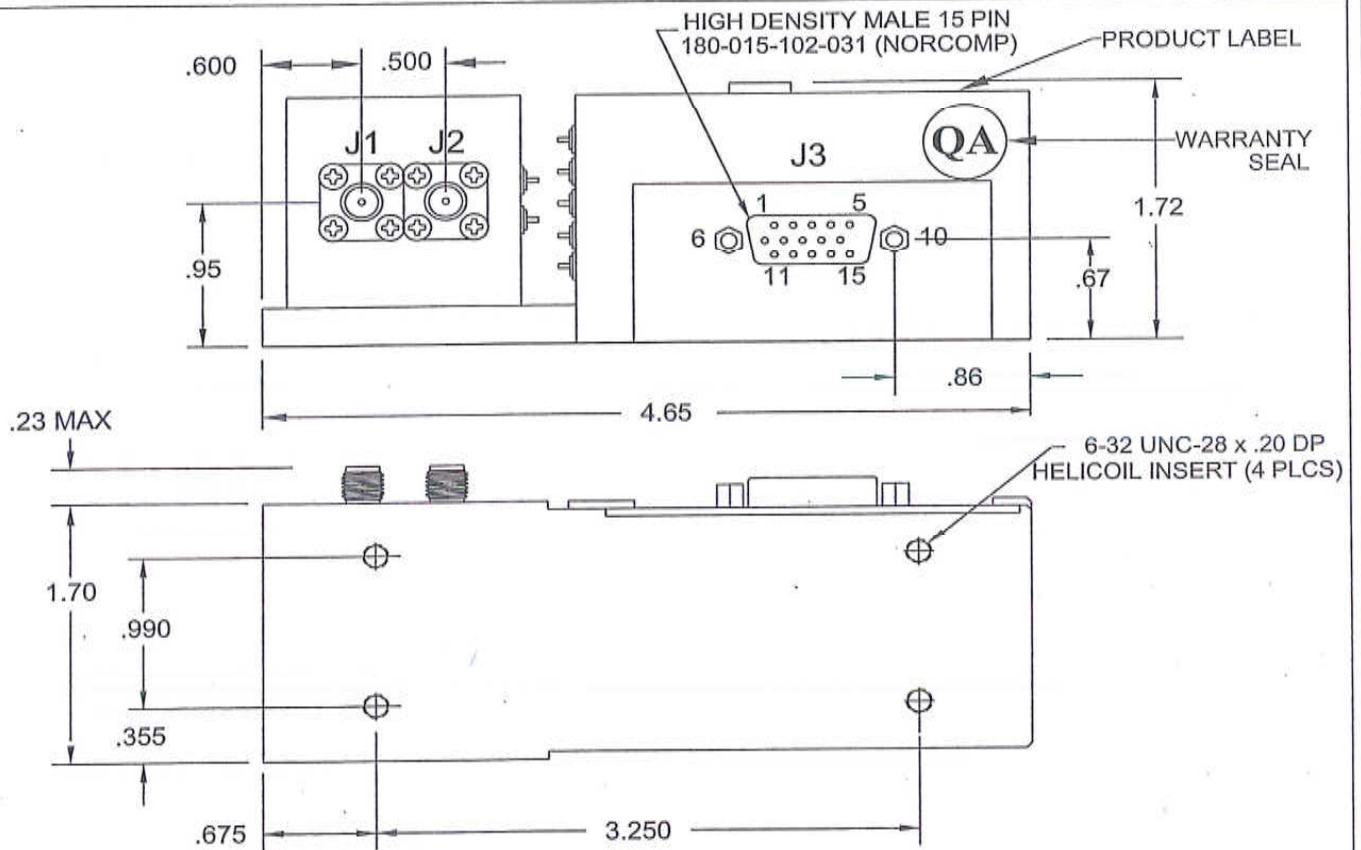

NOTES :

- 1. - DIMENSIONS ARE IN INCHES
- 2. - SUPPLY & GROUND WIRES = 20-22 GAUGE
ALL OTHER WIRES = 24-26 GAUGE

CONNECTIONS			
CONN.	TYPE	PIN #	FUNCTION
J3	DB15 MALE	1	CLOCK
J3	DB15 MALE	2	DATA
J3	DB15 MALE	3	C SELECT N
J3	DB15 MALE	4	GROUND
J3	DB15 MALE	5	- V SUPPLY
J3	DB15 MALE	6	+ V SUPPLY
J3	DB15 MALE	7	HEATER 1
J3	DB15 MALE	8	HEATER 2
J3	DB15 MALE	9	N/C
J3	DB15 MALE	10	N/C
J3	DB15 MALE	11	N/C
J3	DB15 MALE	12	N/C
J3	DB15 MALE	13	N/C
J3	DB15 MALE	14	N/C
J3	DB15 MALE	15	N/C

CONNECTIONS			
CONN.	TYPE	PIN #	FUNCTION
J1	SMA FEMALE	THD	RF IN
J2	SMA FEMALE	THD	RF OUT

<small>UNLESS OTHERWISE SPECIFIED DIMENSIONS ARE IN INCHES TOLERANCE ARE:</small> <small>FRACTIONS DECIMALS ANGLES</small> <small>± .010 ± .02 ± .010</small>	CONTRACT NO.			MICRO LAMBDA WIRELESS, INC.			
	APPROVALS	DATE					
WEIGHT	20 oz.	DRAWN	N.NGUYEN	8/16/11	1.4" BRW WITH 16 BIT SERIAL DRIVER		
FINISH		ENGR.	DS	8/16/11			
DO NOT SCALE DRAWING	MANUF.	G.A.	Q.A.	SIZE	CAGE No	DWG. NO.	REV.
				0RN63	99 - 0021 - 070	C	

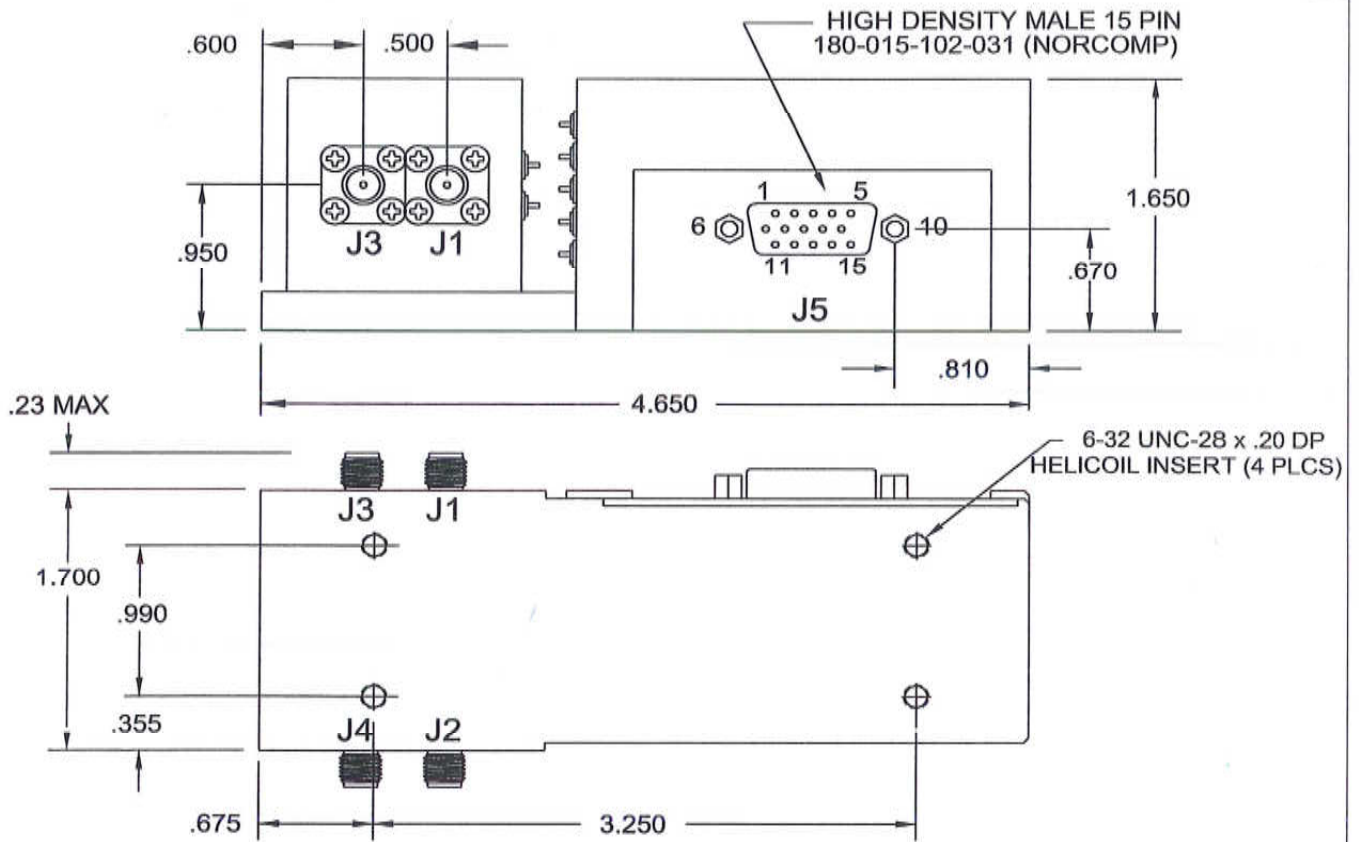

NOTES :

1. - DIMENSIONS ARE IN INCHES
2. - SUPPLY & GROUND WIRES = 20-22 GAUGE
ALL OTHER WIRES = 24-26 GAUGE
3. - THERMAL COMPOUND REQUIRED BETWEEN
BASE PLATE AND MOUNTING SURFACE

CONNECTIONS			
CONN.	TYPE	PIN #	FUNCTION
J1	SMA FEMALE	THD	RF IN
J2	SMA FEMALE	THD	RF OUT
J3	SMA FEMALE	THD	RF IN
J4	SMA FEMALE	THD	RF OUT

CONNECTIONS			
CONN.	TYPE	PIN #	FUNCTION
J5	DB15 MALE	1	CLOCK
J5	DB15 MALE	2	DATA
J5	DB15 MALE	3	C SELECT N
J5	DB15 MALE	4	GROUND
J5	DB15 MALE	5	- V SUPPLY
J5	DB15 MALE	6	+ V SUPPLY
J5	DB15 MALE	7	HEATER 1
J5	DB15 MALE	8	HEATER 2
J5	DB15 MALE	9	N/C
J5	DB15 MALE	10	N/C
J5	DB15 MALE	11	N/C
J5	DB15 MALE	12	N/C
J5	DB15 MALE	13	N/C
J5	DB15 MALE	14	N/C
J5	DB15 MALE	15	N/C

UNLESS OTHERWISE SPECIFIED DIMENSIONS ARE IN INCHES
TOLERANCE ARE
FRACTIONS DECIMALS ANGLES
- xx .020
+ xxx .005

WEIGHT 20 oz.

FINISH

DO NOT SCALE DRAWING

CONTRACT NO.

APPROVALS DATE

DRAWN N.NGUYEN 11/11/08

ENGR DS 11/11/08

MANUF

QA



MICRO LAMBDA WIRELESS, INC.

1.4" DUAL BRF WITH 16 BIT SERIAL DRIVER

SIZE	CAGE No ORN63	DWG. NO. 21 - 113	REV.
------	-------------------------	-----------------------------	------